

Talkabout T82/ T82 EXTREME

OWNER'S MANUAL

en-US	da-DK	de-DE	es-ES	fr-FR
it-IT	hu-HU	nl-NL	nb-NO	pl-PL
pt-PT	ru-RU	fi-FI	sv-SE	tr-TR
uk-UA				

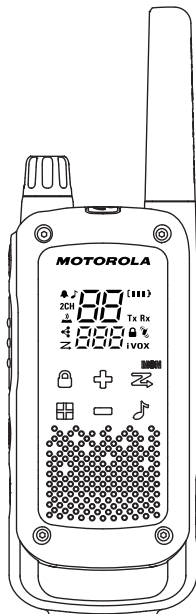

RF ENERGY EXPOSURE AND PRODUCT SAFETY GUIDE FOR PORTABLE TWO-WAY RADIOS

ATTENTION!

Before using this product, read the RF Energy Exposure and Product Safety Guide that ships with the radio which contains instructions for safe usage and RF energy awareness and control for compliance with applicable standards and regulation.

Package Contents

Package Content	T82	T82 Extreme	T82 Extreme Quad	T82 Extreme RSM
Radio	2	2	4	2
Belt clip	2	2	4	2
Lanyard	0	2	4	0
Battery	2	2	4	2
Power Supply	1	1	2	1
Headset with boom mic	0	2	4	0
RSM	0	0	0	2
Stickersheet(16pcs)	1	1	2	1
Owner's manual	1	1	1	1
Carrycase	0	1	1	1

Personalization Stickers:
16 stickers (twin pack)/32 stickers (quad pack) provided in order to personalize and keep track of radios. Use permanent marker for the blank stickers.

Frequency Chart

Ch.	Freq. (MHz)	Ch.	Freq. (MHz)	Ch.	Freq. (MHz)
1	446.00625	7	446.08125	13	446.15625
2	446.01875	8	446.09375	14	446.16875
3	446.03125	9	446.10625	15	446.18125
4	446.04375	10	446.11875	16	446.19375
5	446.05625	11	446.13125		
6	446.06875	12	446.14375		

Note: Only Channels 1 to 8 are available by default. Channels 9 to 16 need to be activated by user before they can be selected. Channels 9 to 16 should only be used in countries where these frequencies are allowed by government authorities. Channels 9 to 16 are not allowed in Russia.

Features and Specifications

- 8 PMR Channels. User expandable to 16 Channels in countries where allowed by government authorities.
- 121 Sub-Codes (38 CTCSS Codes & 83 DCS codes)
- Up to 10 km Range*
- iVOX/VOX
- Easy Pairing
- LED Flashlight
- 20 Selectable Call Tone Alerts
- Segmented LED Display
- Roger Tone
- Micro USB Connector for charging
- Battery Level Meter
- Channel Monitor
- Channel Scan
- Dual Channel Monitor
- Keypad Lock
- Auto Squelch Control
- Auto Repeat (Scrolling)
- Battery Low Alert
- Keypad Tone (On/Off)
- Silent Mode (Vibrate Alert)
- Emergency Features
- IP Rating: IPx4
- Power Source: NiMH battery Pack/3 x AA Alkaline batteries
- Battery Life: Up to 18 hours (under typical use conditions)

Note: *Range may vary depending on environmental and/or topographical conditions.

Radio Control Buttons and Display

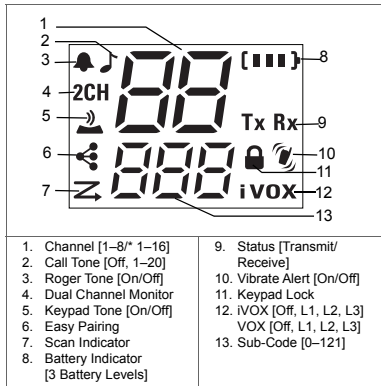
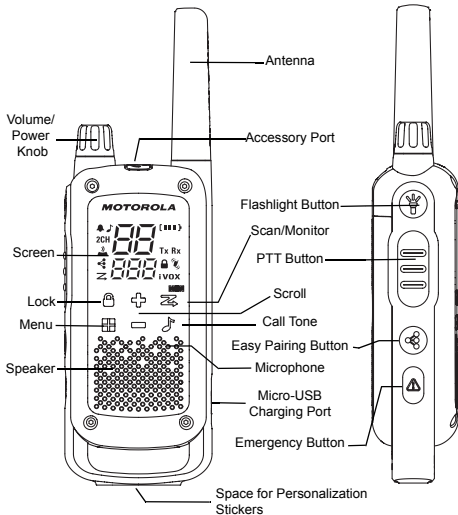

1. Channel [1–8/* 1–16]
2. Call Tone [Off, 1–20]
3. Roger Tone [On/Off]
4. Dual Channel Monitor
5. Keypad Tone [On/Off]
6. Easy Pairing
7. Scan Indicator
8. Battery Indicator [3 Battery Levels]

9. Status [Transmit/Receive]
10. Vibrate Alert [On/Off]
11. Keypad Lock
12. iVOX [Off, L1, L2, L3]
13. Sub-Code [0–121]

Note: The radio screen will dim 5 seconds after the last button is pressed. Radio screen will turn off after another 5 seconds for battery saving purpose, only an LED will be shown blinking. Press any button (except Flashlight button) to resume the display.

Note: *Only Channels 1 to 8 are available by default. Channels 9 to 16 need to be activated by user before they can be selected. Channels 9 to 16 should only be used in countries where these frequencies are allowed by government authorities. Channels 9 to 16 are not allowed in Russia.

Installing the Batteries

Each radio can either use a NiMH rechargeable battery pack or three units of AA Alkaline Battery, and beeps when the batteries are low.

1. Make sure your radio is turned OFF.
2. With the back of the radio facing you, push the latch to the left to unlock the battery door.
3. For NiMH battery pack, insert the battery pack with the ⊕ and ⊖ signs facing you. Observe polarity.
For AA Alkaline batteries, insert the batteries. Observe polarity.
4. Close the battery door and push the latch to the right to lock the battery door.

Radio Battery Meter

The number of bars (0–3) on the Radio Battery icon shown indicates the charge remaining in the battery. When the radio battery meter shows one segment left, the radio chirps periodically or after releasing the PTT button (Low Battery Alert).

Battery Capacity Maintenance

1. Charge the NiMH batteries once every three months when not in use.
2. For storage purposes, remove the battery from the radio.
3. Store the NiMH batteries in a temperature between -20 °C to 35 °C and in low humidity. Avoid damp conditions and corrosive materials.

Using the Micro-USB Charger

The micro-USB charger allows you to charge your NiMH battery pack.

1. Power off your radio before start charging.

2. Plug the micro-USB cable into the micro-USB charging port on your radio. Connect the other end of the micro-USB charger to wall power outlet.
3. An empty battery will be fully charged in 8 hours.
4. The battery meter bar will scroll when the battery is charging.

Note: It is recommended to power OFF your radio while charging.

However, if power is ON while charging, you may not be able to transmit a message if the battery is completely empty. Allow time for the battery to charge to one bar before attempting to transmit a message.

When moving between hot and cold temperatures, do not charge the NiMH battery pack until the temperature acclimates (usually about 20 minutes).

For optimal battery life, remove the radio from the charger within 16 hours. Do not store the radio while connected to the charger.

Turning your Radio On and Off

To turn your radio ON, turn the rotary knob clockwise.

To turn your radio OFF, turn the rotary knob counterclockwise.

Setting the Volume

Increase volume by turning the rotary knob clockwise.

To decrease volume, turn the rotary knob counterclockwise.

Do not hold the radio close to your ear. If the volume is set to an uncomfortable level, it could hurt your ear.

Talking and Listening

All radios in your group must be set to the same channel and Sub-Code in order to communicate.

1. Hold your radio 2–3 cm from your mouth.
2. Press and hold the PTT button while speaking. The Transmit Tx icon appears on the display.

3. Release the PTT button. You can now receive incoming calls. When you do, the Receive Rx icon appears on the display.

For maximum clarity, hold the radio 2 to 3 cm away and avoid covering the microphone while talking.

Talk Range

Your radio is designed to maximize performance and improve transmission range. Ensure the radios are at least 5 feet apart when in used.

Monitor Button

Pressing and holding  Scan/Monitor for 3 seconds to enter Monitor mode and listen for weak signals on the current channel. You can also listen to the volume level of the radio when you are not receiving. This allows you to adjust the volume, if necessary.

Push-to-Talk Time-out Timer

To prevent accidental transmissions and save battery life, the radio emits a continuous warning tone and stops transmitting if you press the PTT button for 60 seconds continuously.



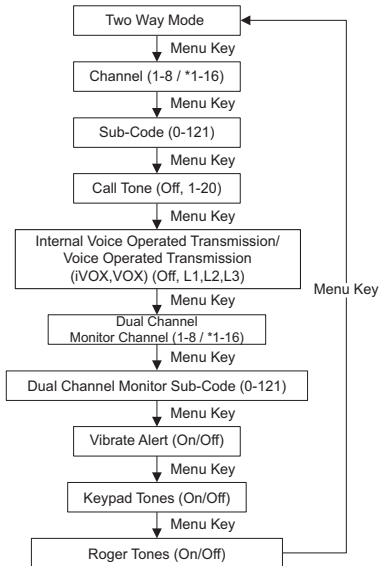

Menu Options

Note: *Only Channels 1 to 8 are available by default. Channels 9 to 16 need to be activated by user before they can be selected. Channels 9 to 16 should only be used in countries where these frequencies are allowed by government authorities. Channels 9 to 16 are not allowed in Russia.





Selecting the Channel

The channel is the frequency of the radio uses to transmit.

1. Press  Menu until the channel number starts to flash.
2. Press  or  to change the channel. Long press on these keys allows you to scroll through the channels rapidly to browse the codes.
3. Press PTT button to exit menu or  Menu to continue set up.

Note: Your radio has eight channels by default. In countries where 16 channels are allowed, you can activate Channels 9 to 16 with the following steps:





1. Press  Menu until the channel number starts to flash.
2. Press and hold down  and  simultaneously for 3 seconds until you hear a beep and "16 CH" is displayed briefly.

Note: *Only Channels 1 to 8 are available by default. Channels 9 to 16 need to be activated by user before they can be selected. Channels 9 to 16 should only be used in countries where these frequencies are allowed by government authorities. Channels 9 to 16 are not allowed in Russia.

Selecting the Sub-Code

Sub-Codes help minimize interference by blocking transmissions from unknown sources. Your radio has 121 Sub-Codes.





To set the code for a channel:

1. Press  Menu until the code starts to flash.
2. Press  or  to select the code. You can hold down the button to speed up scrolling through the codes.
3. Press the PTT button to exit menu or  Menu to continue set up.

Setting and Transmitting Call Tones

Your radio can transmit different call tones to other radios in your group so you can alert them that you want to talk. Your radio has 20 call tones for you to choose from.

To set a call tone:

1. Press  Menu until the Call Tone  icon appears. The current call tone setting will flash.
2. Press  or  to change and listen to the call tone.
3. Press the PTT button to exit menu or  Menu to continue set up.

In order to transmit your call tone to other radios, set up the same channel and Sub-Code on your radio and press  Call Tone.

Easy Pairing

The Easy Pairing feature allows a group of radio users to program all their radios to the same Channel and Sub-Code settings quickly and simultaneously. Any one radio within the group can be designated as the "Leader's radio" and have it's Channel and Sub-Code settings transmitted to and copied by all the other radios in the group (Members' radios).

1. Pick any one of the radios as the "Leader's radio". On this radio, program the Channel and Sub-Code to the desired settings. (See "Selecting the Channel" and "Selecting the Sub-Code" sections in this user manual)
2. To copy the channel and Sub-Code combination to all the other "Members' radios", press and hold the  button on the Members' radios until you hear a beep. Release the button after the beep, and wait for the transmission from the Leader's radio.

Note:

- You will see the  icon blinking on the display. This confirms that the radio is in Easy Pairing mode waiting to receive the Channel

and Sub-Code settings from the Leader's radio. All Members' radios will remain in this mode for 3 minutes.

- A group with many radios should have all users take this step at the same time, so all radios can be programmed in one go.

3. On the Leader's radio, press and hold down the button until you hear a double beep.

Note:

- At the double beep, this radio's Channel and Sub-Code settings will be transmitted, which will be received and copied by all the other (Members') radios.
- The Leader's radio must make this transmission when all the Members' radios are still in the Easy Pairing mode, otherwise the transmission will not be picked up.
- On the Leader's radio, user must remember NOT to release the button on the first (single) beep, otherwise this radio will become another Member's radio. If that happens, you can press PTT to escape, and retry the steps described in #3 again.
- If the Leader's radio is set to a channel between 9 and 16, please ensure that all Members' radios have channels 9 to 16 activated.
- When a Member's radio with only 8 Channels is being Easy-Paired by a Leader's radio on Channel 9 or above, Easy-Pairing will fail, indicated by three short beeps, and "Err" is displayed briefly.



Internal Voice Operated Transmission/ Voice Operated Transmission (iVOX/VOX)

Transmission is initiated by speaking into the microphone of the radio/audio accessory instead of pushing the PTT button.

L3 = High Sensitivity for quiet environments
L2 = Medium Sensitivity for most environments
L1 = Low Sensitivity for noisy environments

1. Press  Menu until the **iVOX** icon appears on the display. When audio accessory is connected, the **VOX**

icon will be shown. The current setting (Off, L1–L3) will flash.







2. Press  or  to select the sensitivity level.
3. Press the PTT button to exit menu or  Menu to continue set up.

Note: When using iVOX/VOX, there will be a short delay.

Dual Channel Monitor

Enables you to scan the current channel and another channel alternately.



To set another channel and start Dual Channel Monitor:



1. Press  Menu until the Dual Channel Monitor **2CH** icon appears. The Dual Channel Monitor icon will flash.
2. Press  or  to select the channel then press  Menu.
3. Press  or  to select the Sub-Code.
4. Press the PTT button or wait until time out to activate Dual Channel Monitor. The screen will alternate between home channel and Dual Channel Monitor channel.
5. To end Dual Channel Monitor, press  Menu.

Note: If you set the same channel and Sub-Code as the current channel, Dual Channel Monitor does not work.

Silent Mode (Vibrate Alert)





Silent Mode (Vibrate Alert) notifies you that your radio is receiving a message. This is useful in noisy environments. The Vibrate Alert will be triggered when you received a call. It will then only be triggered again if there is no activity within 30 seconds after the previous call.

1. Press  Menu until the Vibrate Alert  icon is displayed. The current setting will flash.

2. Press  or  to change the setting to On/Off.
3. Press the PTT button to exit menu or  Menu to continue set up.





Keypad Tones

You may enable or disable the keypad tones. You will hear the key tone each time a button is pushed.

1. Press  Menu until the Keypad Tone  icon appears. The current setting On/Off will flash.
2. Press either  or  to turn On/Off.
3. Press the PTT button to confirm or  Menu to continue set up.

Roger Tone

You can set your radio to transmit a unique tone when you finish transmitting. It is like saying “Roger” or “Over” to let others know you have finished talking.

1. Press  Menu until the Roger Tone  icon appears. The current setting On/Off flashes.
2. Press  or  to turn On or Off.
3. Press the PTT button to set or  Menu to continue set up.

Emergency Alert Mode

The Emergency Alert feature can be used to signal members in your group for help. T82/T82 Extreme radios will operate in an automatic “hands-free” emergency control mode for a total of 30 seconds after activating the Emergency Alert. T82/T82 Extreme radios in your group will automatically advance the speaker volume to the maximum setting and sound a warbling alert tone for 8 seconds. The alert tone is

emitted from your own radio speaker and the receiving radios in your group. After the 8 second alert, any spoken words or incidental sounds at your end will be transmitted to the group for 22 seconds. For the 30 second duration of Emergency Alert mode, T82/T82 Extreme radio controls and buttons will be locked to maximize reception of the emergency message.

1. Press and hold the Emergency Alert button for 3 seconds.
2. Release the button and the alert tone begin to sound. There is no need to continue to hold the Emergency Alert button or use PTT for your message to be transmitted.

WARNING: The Emergency Alert feature should only be used in the event of an actual emergency. Motorola Solutions is not responsible if there is no response to the emergency alert from the receiving group.





LED Flashlight

Your radio has a built-in-LED Flashlight.

The LED Flashlight will remain on until the button is released.

Keypad Lock

To avoid accidentally changing your radio settings:

1. Press and hold  Key Lock until the Key Lock Indicator  icon displays.
2. You can turn the radio ON and OFF, adjust the volume, receive, transmit, send a call tone, send Emergency Alert, and monitor channels when in the lock mode. All other functions remain locked.
3. Press  Key Lock and hold until the  Key Lock Indicator is no longer displayed to unlock the radio.

Scanning

Use the scan function to do the following:

- Search all channels for transmissions from unknown parties.
- Find someone in your group who has accidentally changed channels or
- Find unused channels quickly for own usage.

There is a priority feature and two modes of scanning (basic and advanced) to make your search more effective.



- The “Basic Scan” mode uses the channel and code combinations for each of the channels as you have set them (or with the default code value of 1).
- The “Advance Scan” mode will scan all channels for any and all codes; detect any code in use and use that code value temporary for that channel.
- Priority is given to the “Home Channel” (i.e. the channel and Sub-Code your radio is set to when you start the scan). This means the initial channel (and code settings) is scanned more often than the other seven channels and your radio will respond quickly to any activity occurring on the home channel as a priority.

To start Basic Scanning:







1. Press the  Scan/Monitor button briefly. The Scan Z icon will appear in the display and the radio will begin to scroll through the channel and code combinations.
2. When the radio detects channel activities matching the channel and Sub-Code combination, the radio will stop scrolling and you can hear the transmission.
3. Press the PTT button within 5 seconds after the end of the transmission to respond and talk to the person transmitting.

4. The radio will resume scrolling through the channels 5 seconds after the end of any received activity.
5. Press the  Scan/Monitor button briefly to stop scanning.

To start Advanced Scanning:

1. Set home channel's Sub-Code to “zero” or OFF.
2. Press the  Scan/Monitor button briefly. The Scan Z icon will appear in the display and the radio will begin to scroll through the channels. No Sub-Codes will filter what is heard.
3. When the radio detects channel activities with ANY code (or NO code), it stops scrolling and you can hear the transmission. Any Sub-Code that may be use by other party will be detected and displayed.
4. To respond and talk to the person transmitting, press the PTT button within 5 seconds after the end of the transmission.
5. The radio will resume scrolling through the channels 5 seconds after the end of any received activity.
6. Press the  Scan/Monitor button briefly to stop scanning.

Note:

1. The transmission will be on the "Home Channel" if you press the PTT button while the radio is scrolling through inactive channels. You may press the  Scan/Monitor button to stop scanning at any time.
2. You may immediately resume the scan by briefly pressing  or  if the radio stops on an undesired transmission.
3. You may temporarily remove that channel from the scan list by pressing and holding  or  for 3 seconds if the radio stops repeatedly on an undesired transmission. You may remove more than one channel this way.
4. Turn the radio OFF and then turn back ON, or EXIT and re-enter the scanning mode by pressing  Scan/Monitor to restore the removed channel(s) to the scan list.
5. You cannot remove the "Home Channel" from the scan list.
6. In the Advanced Scan, the detected code will only be used for one transmission. You must take note of that code, exit scan, and set the detected code on that channel to permanently use.

Warranty Information

The authorized Motorola Solutions dealer or retailer where you purchased your Motorola Solutions two-way radio and/or original accessories will honour a warranty claim and/or provide warranty service.

Please return your radio to your dealer or retailer to claim your warranty service. Do not return your radio to Motorola Solutions.

In order to be eligible to receive warranty service, you must present your receipt of purchase or a comparable substitute proof of purchase bearing the date of purchase. The two-way radio should also clearly display the serial number. The warranty will not apply if the type or serial numbers on the product have been altered, deleted, removed, or made illegible.

What Is Not Covered By The Warranty

- Defects or damage resulting from use of the Product in other than its normal and customary manner or by not following the instructions in this user manual.
- Defects or damage from misuse, accident or neglect.
- Defects of damage from improper testing, operation, maintenance, adjustment, or any alteration or modification of any kind.
- Breakage or damage to aerials unless caused directly by defects in material or workmanship.
- Products disassembled or repaired in such a manner as to adversely affect performance or prevent adequate inspection and testing to verify any warranty claim.
- Defects or damage due to range.
- Defects or damage due to moisture, liquid or spills.
- All plastic surfaces and all other externally exposed parts that are scratched or damaged due to normal use.
- Products rented on a temporary basis.
- Periodic maintenance and repair or replacement of parts due to normal usage, wear and tear.

Copyright Information

The Motorola Solutions products described in this manual may include copyrighted Motorola Solutions programs, stored semiconductor memories or other media. Laws in the United States and other countries preserve for Motorola Solutions, certain exclusive rights for copyrighted computer programs, including the exclusive right to copy or reproduce in any form, the copyrighted Motorola Solutions programs.

Accordingly, any copyrighted Motorola Solutions computer programs contained in the Motorola Solutions products described in this manual may not be copied or reproduced in any manner without express written permission of Motorola Solutions. Furthermore, the purchase of Motorola Solutions products shall not be deemed to grant either directly or by implication, estoppel, or otherwise, any license under the copyrights, patents or patent applications of Motorola Solutions, except for the normal non-exclusive royalty free license to use that arises by operation of law in the sale of a products.

NOTES



MOTOROLA SOLUTIONS

MOTOROLA, MOTO, MOTOROLA SOLUTIONS and the Stylized M logo are trademarks or registered trademarks of Motorola Trademark Holdings, LLC and are used under license. All other trademarks are the property of their respective owners. © 2017 Motorola Solutions, Inc. All rights reserved.



MN003428A01-AC

Printed in China.